

Full Arch Treatment

Multi Abutment

Multi Abutment

Multi Angled Abutment

OSSTEM[®]
IMPLANT



Multi Abutment

Unlock the limitless potential of your practice with Multi Abutment's exceptional clinical versatility. The Multi Abutment promises superior results, overcoming the limitations of full-arch treatment. Elevate your practice to the next level by incorporating the Multi Abutment, the ultimate solution to expand your capabilities.



Case



Bridge

Fixed Full denture

Bar with removable full denture

The concept of Full-arch treatment

The Full-arch treatment offers the possibility of creating a full-arch restoration with minimal implant placement that reduces the cost and treatment time.

Depending on the surgical plan, it is possible to select the suitable implant system. Moreover, by using the Multi Abutment, Multi Angled Abutment and other various components, diverse restoration options can be selected for each case.

Furthermore, a diverse range of restorations can be fabricated with ease using the support of the latest digital libraries and CAD/CAM technology.

Thus, Osstem implant provides effective support for the full-arch treatment.



Multi Abutment

Various Gingival Heights

· Various gingival heights from 1mm to 5mm are available.

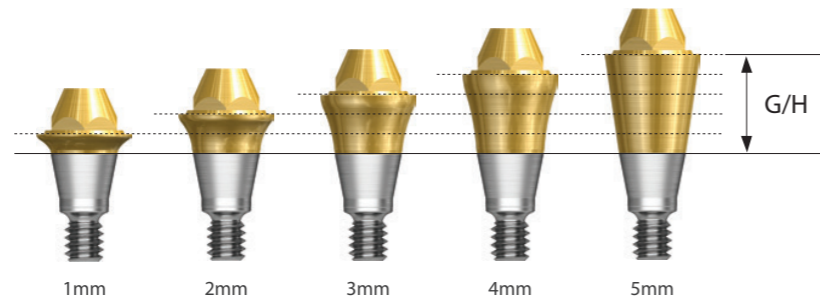

Various Combination Options

· A variety of prosthetic components and cylinders can be used for each case and numerous types of prosthetics are provided.

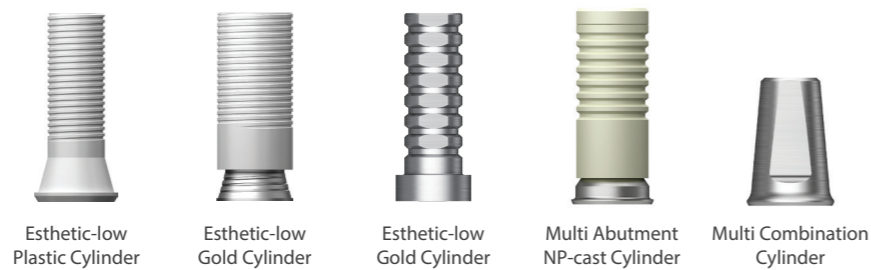

· Since the Multi Abutment is attached to an internal submerged implant, it functions optimally.

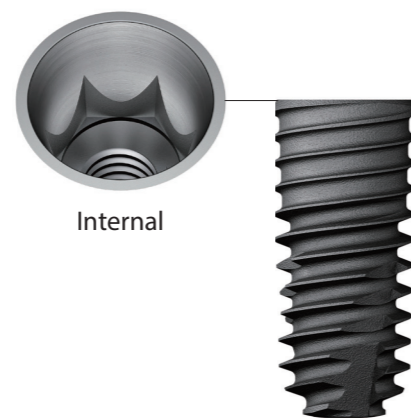

Multi Angled Abutment

Two Angulation Options

· The Multi Abutment offers two options of 17 degree and 30 degree angles which act as compensation angles for the implants that had been implanted at the prosthetic engagement stage. This means that they can cover a wide range of clinical cases.

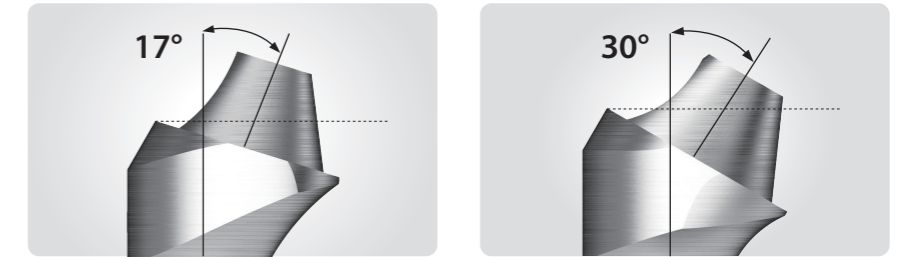

Various Gingival Heights

· A wide range of gingival heights from 2.5mm to 5mm are available.

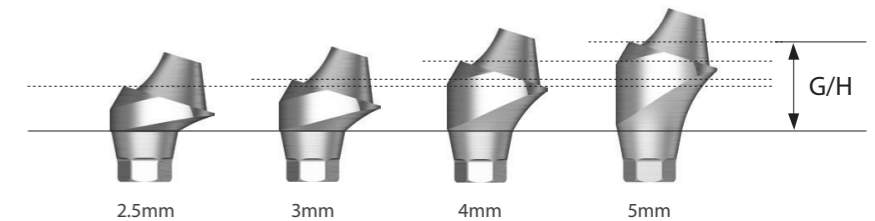

* In case 17 degree angles

Divergence Compensation

· Additional compensation can be made with the angle at the top of the abutment to compensate for up to 108 degrees.

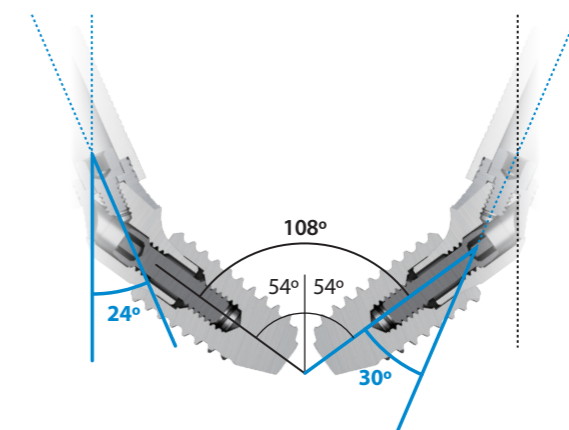

24°

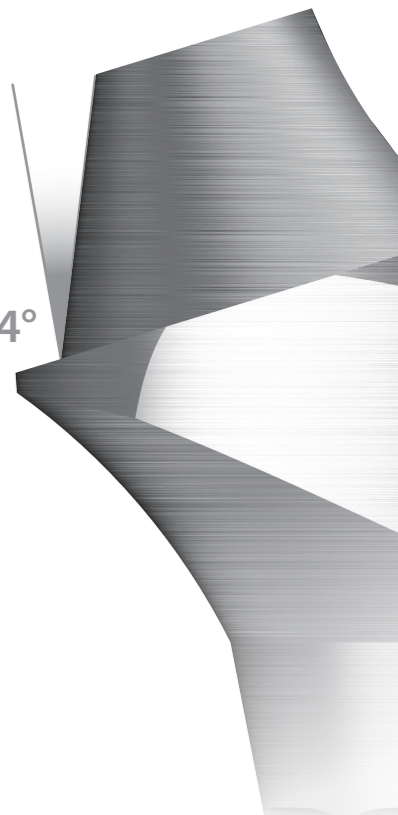

Components & Tools

Conventional

Cylinder



Esthetic-low Temporary Cylinder
Used for fabrication of temporary prosthesis



Multi Combination Cylinder
Used for producing combination prosthesis



Esthetic-low Gold Cylinder
Used for fabrication of customized prosthesis by casting with gold alloys



Esthetic-low Gold Cylinder
Used for fabrication of customized prosthesis by casting with nonprecious metal alloys

Impression



Esthetic-low Transfer Coping



Esthetic-low Pick-up Coping

Lab Analog



Esthetic-low Lab Analog

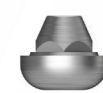

Esthetic-low Polishing Protector
Protecting the joint in the polishing procedure after producing a prosthesis using esthetic GoldCast/plastic cylinder



Esthetic-low Healing Cap
Protect cap for Esthetic-low Abutment



Multi Abutment Outer Driver
A dedicated torque Driver for Straight multi abutment

Digital

*Digital libraries are available for the following manufacturers

3shape

exocad

dental wings
A Straumann Group Brand

Cylinder



Multi Ti Base
• Used for fabrication of combination-retained prosthesis in TS Multi Abutment
• Used by connecting it to the TS Multi Scan Body / OR – To be used, it is connected to the TS Multi Scan Body

Impression



Multi Scan Body
Used for oral scanning by connecting to TS Multi Abutment

Lab Analog



Multi Digital Lab Analog



Reamer Drill

Used for correction of insertion path of 3D-printed working mode



Positioning Jig

Used for inserting Lab Analog to the working model in the accurate hex direction

Optional Components

Temporary Restoration

Temporary prosthetics can be set immediately after surgery by the use of a Temporary Cylinder. It results in a high treatment satisfaction by minimizing dental patient's functional, aesthetic, and psychosocial discomfort.

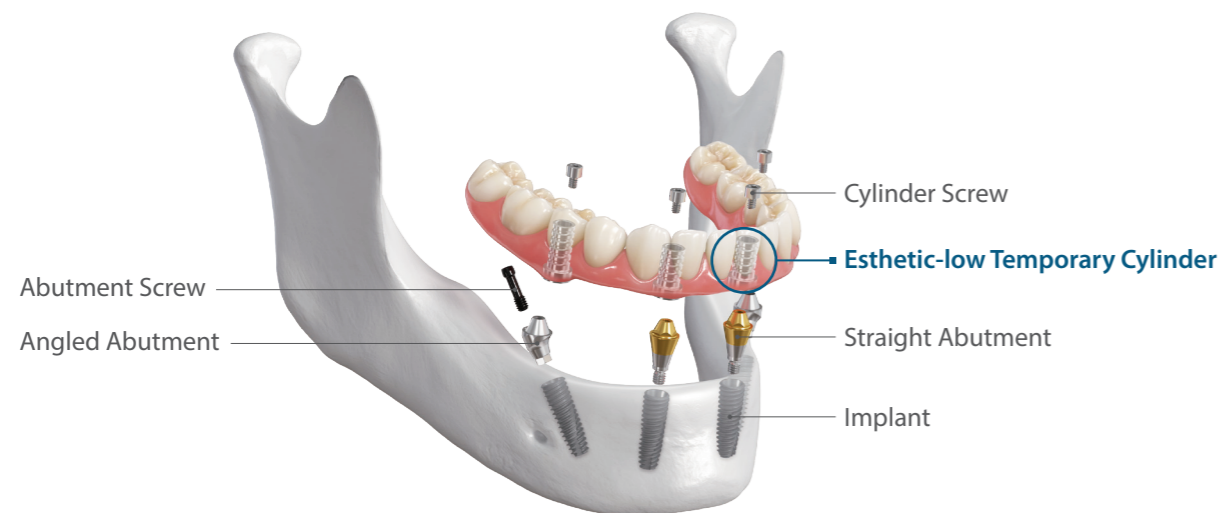

Esthetic-low Temporary Cylinder

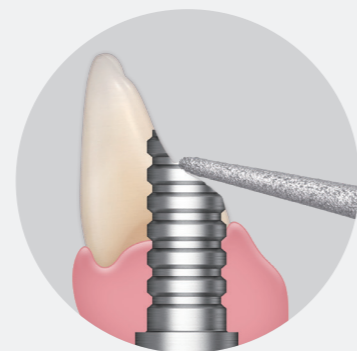
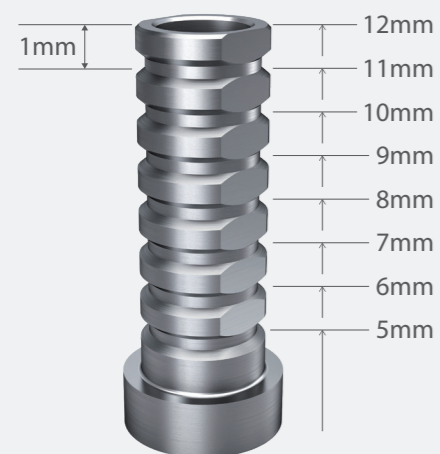

The temporary cylinder which is used at the temporary restoration has a total length of 12mm. It is easy to adjust the length of the cylinder due to the fact that it is divided into sections of 1mm from the top to the bottom part.

Digital Restoration

*Digital libraries are available for the following manufacturers



Experience the benefits of digital manufacturing with the Multi Ti Base. Digital prosthetics allow greater precision and customization. The Multi Ti Base is compatible with every type of Multi/Multi Angled Abutment and a variety of Software provides digital libraries.

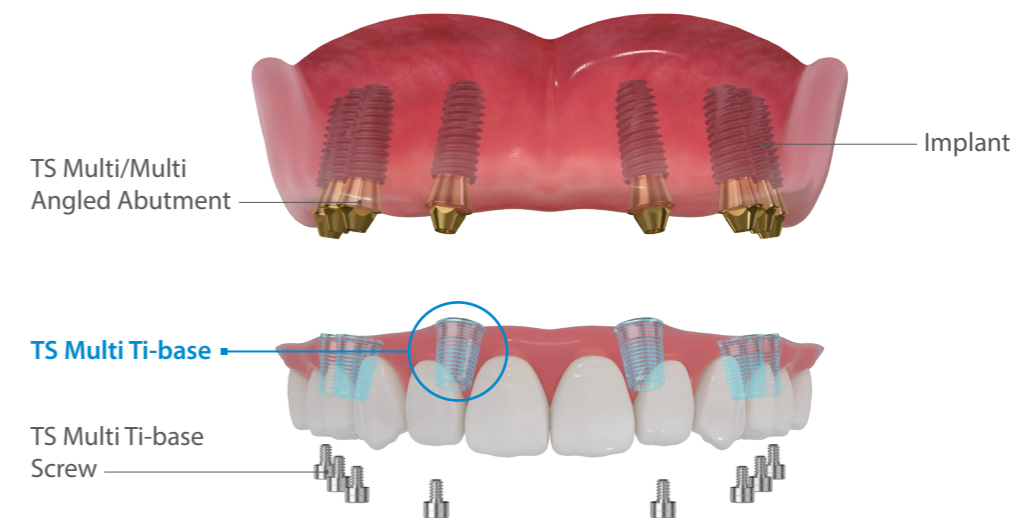

Angled Torque Driver

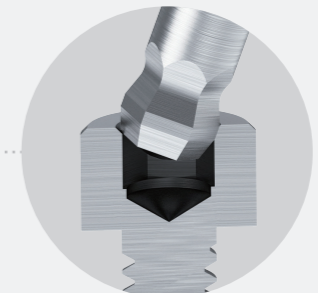
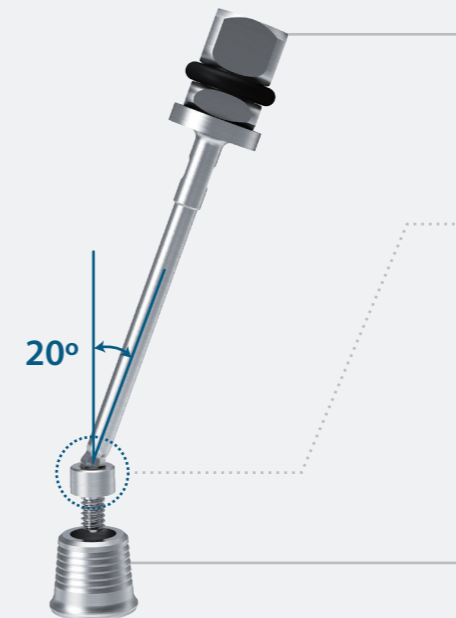

Due to the round hex shape of the driver, tightening of the screw is made possible even if the driver is tilted up to 20 degrees.

Multi Ti-base

Even in completely edentulous case, perfect passive fit is possible and the screw type of the full denture is optimized through the titanium base.

Multi Abutment

PRODUCT OVERVIEW

Abutment 11

Prosthetic Components 12

Impression Components 12

Placement Tool 13

For Digital Prosthetics 14

Abutment

Multi Abutment Packing unit : Abutment + Carrier(*)

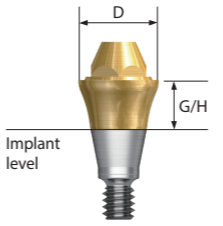

D \varnothing 4.8 **M**

D \varnothing 4.8 **R**

*Carrier

G/H	1.0	2.0	3.0	4.0	5.0
	TSMA5010MP	TSMA5030MP	TSMA5030MP	TSMA5040MP	TSMA5050MP
G/H	1.0	2.0	3.0	4.0	5.0
	TSMA5010P	TSMA5030P	TSMA5030P	TSMA5040P	TSMA5050P

Multi Angled Abutment Packing unit : Abutment + Carrier(*) + EbonyGold Screw(*)

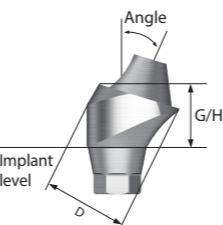

D \varnothing 4.8 **M**

D \varnothing 4.8 **R**

*Carrier

*EbonyGold Screw
Mini : GSMABSM
Regular : GSMABSS

Angle	G/H	2.5	3.0	4.0	
17°					
		GS17MAM4820WH	GS17MAM4830WH	GS17MAM4840WH	
Angle	G/H	3.5	4.0	5.0	
30°					
		GS30MAM4830WH	GS30MAM4840WH	GS30MAM4850WH	
Angle	G/H	2.5	3.0	4.0	5.0
17°					
		GS17MAS4820WH	GS17MAS4830WH	GS17MAS4840WH	GS17MAS4850WH
Angle	G/H	3.5	4.0	5.0	
30°					
		GS30MAS4830WH	GS30MAS4840WH	GS30MAS4850WH	

Prosthetic Components

Packing unit : Cylinder + Ti Cylinder Screw(*)

Esthetic-low Temporary Cylinder

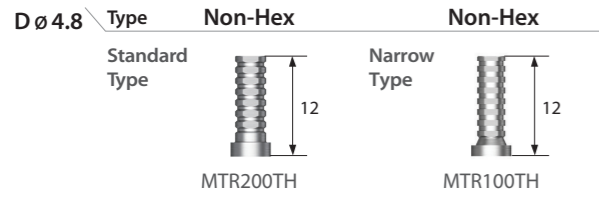

Multi Combination Cylinder

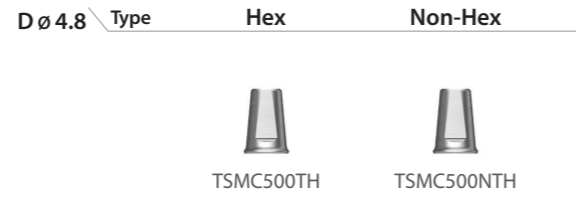

Multi Abutment NP-Cast Cylinder



Esthetic-low Gold Cylinder

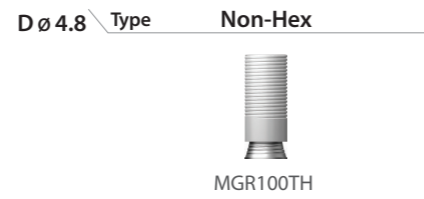

Esthetic-low Plastic Cylinder

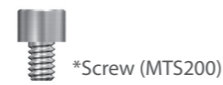
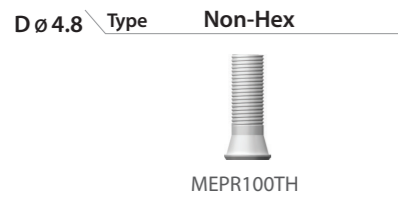

Impression Components

Esthetic-low Pick-up Impression Coping

Packing unit : Impression coping body + Guide pin(*)

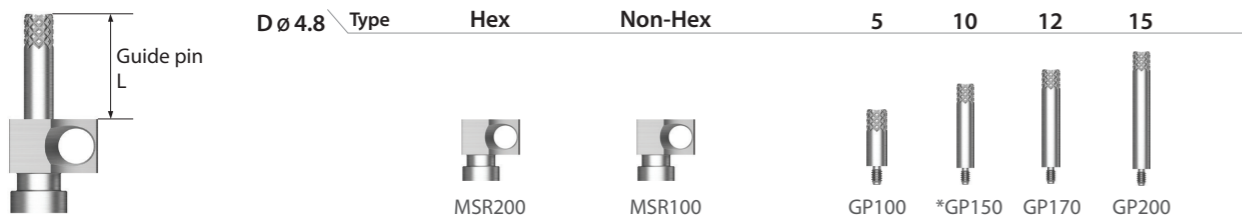

Esthetic-low Transfer Impression Coping

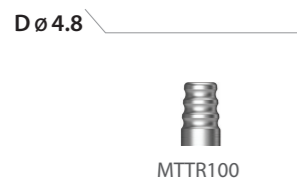

Esthetic-low Lab Analog

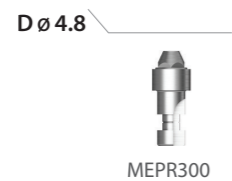

Esthetic-low Polishing Protector

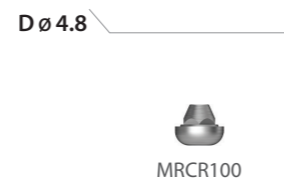

Placement Tool

Torque Driver (1.2 Hex)

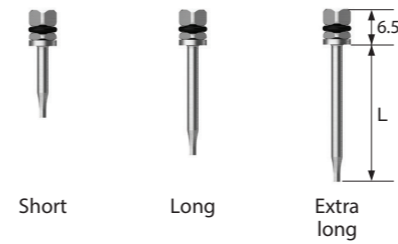

L	Type	1.2 Hex
8	Ex.Short	TRHD12MS
13	Short	TRHD12S
15	Middle	TRHD12M
20	Long	TRHD12L
25	Ex.Long	TRHD12E

Hand Driver (1.2 Hex)

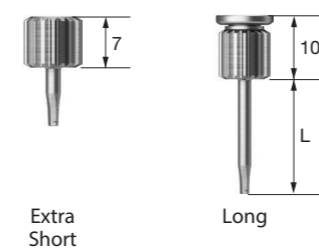

L	Type	1.2 Hex
8	Ex.Short	AHD12MSH
13	Short	AHD12SH
15	Middle	AHD12MH
20	Long	AHD12LH
25	Ex.Long	AHD12EH

Multi Abutment Outer Driver

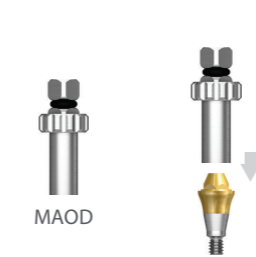

Multi Abutment Outer Driver

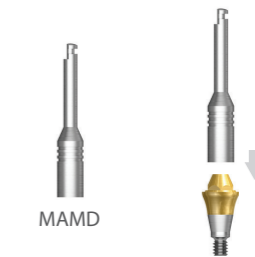

Angled Torque Driver

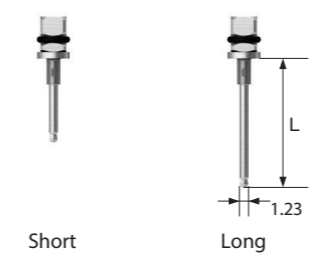

L	Type	1.2 Hex	1.2 Hex (Set)
13	Short	ATD12S	ATD12S3S
20	Long	ATD12L	ATD12L3S

For Digital Prosthetics

*Digital libraries are available for the following manufacturers



TS Multi Ti Base Packing unit : Ti Base + Ti Base Screw(*)

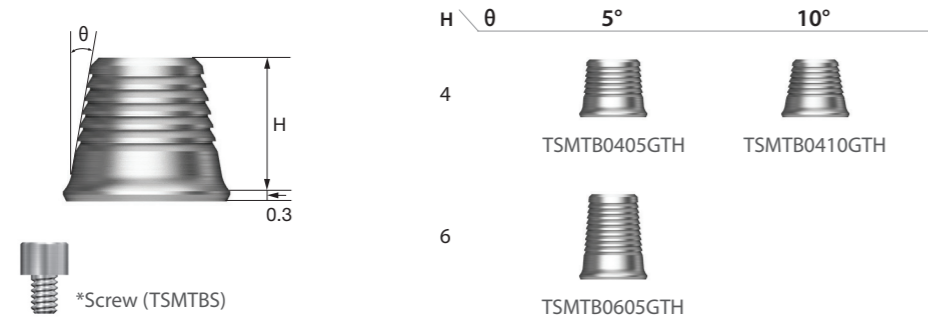

Multi Digital Lab Analog

Packing unit : Digital Lab Analog + Screw



TSMDLA

Positioning Jig



TSMDLAPJ

Multi Scan Body



TMSBC

Screw Bulk (10ea)



TSDLASB



Reamer Drill *Use A Type for Multi Abutment

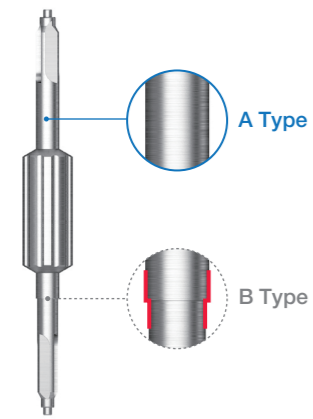

DLARDR